

Ceiling LED Multi Pendant

MP62255
INSTALLATION SHEET

START FROM HERE

- Make sure power is completely off at the fuse box.
- Have your fixture installed by a qualified licensed electrician
- Prepare everything in a clear area.
- Wear gloves at all times during this installation.
- Read instructions carefully before you start assembly.
- Keep this instruction sheet for future reference.

Technical Support: 1-877-452-6858

Please Note:

- All Kuzco LED fixtures come with pre-wired LED module(s).
- Unless instructed to do so, please do not touch any part of the LED module(s) as any unnecessary contact with the module could cause permanent damage.
- For dimming, an ELV (Electronic Low Voltage) type of dimmer is required.

CAUTION: CAUTION: HEAVY FIXTURE, THE JUNCTION BOX NEEDS TO BE REINFORCED BEFORE INSTALLATION. ALL MOUNTING SCREWS MUST SCREW INTO A MINIMUM OF 1" OF WOOD BEHIND THE DRYWALL. DO NOT MOUNT THIS FIXTURE JUST TO DRYWALL. (Be sure all wood that you screwed into, is secured to the cross beams/ceiling joists behind the drywall)

1. Remove the fixture from its original packaging. Next, remove the mounting plate (1c) from within the canopy cover (2a) by removing the four decorative nuts (2c).

2. Install the mounting plate (1c) to the Junction box (1a) with screws (1g).

For additional security add screws (1f) and plastic anchors (1b) through the mounting plate (1c) to the ceiling and wood backing.

To set the fixture hanging height (120" maximum), simply push in the sleeve (2b) at the canopy cover (2a) where the wire comes out from. Once the sleeve is pushed in you can push the wire up to shorten, or pull the wire down to lengthen. When you have selected your desired length, just release the sleeve and the wire will be held tightly in place.

3. You are now ready to mount the canopy cover (2a) to the mounting plate (1c). First connect all wires correctly black to black "L", white to white "N" and the ground wire with provided marettes (1e) from the hardware package. Align the four threaded studs (1d) hanging downward from the mounting plate (1c) to the four holes inside the canopy cover (2a). Push the canopy cover (2a) up towards the ceiling so the threaded studs (1d) point through the holes in the canopy cover (2a). Next, screw on the four decorative nuts (2c) this will secure the canopy cover (2a) to the mounting plate (1c).

4. You have now completed the installation of your fixture, enjoy.

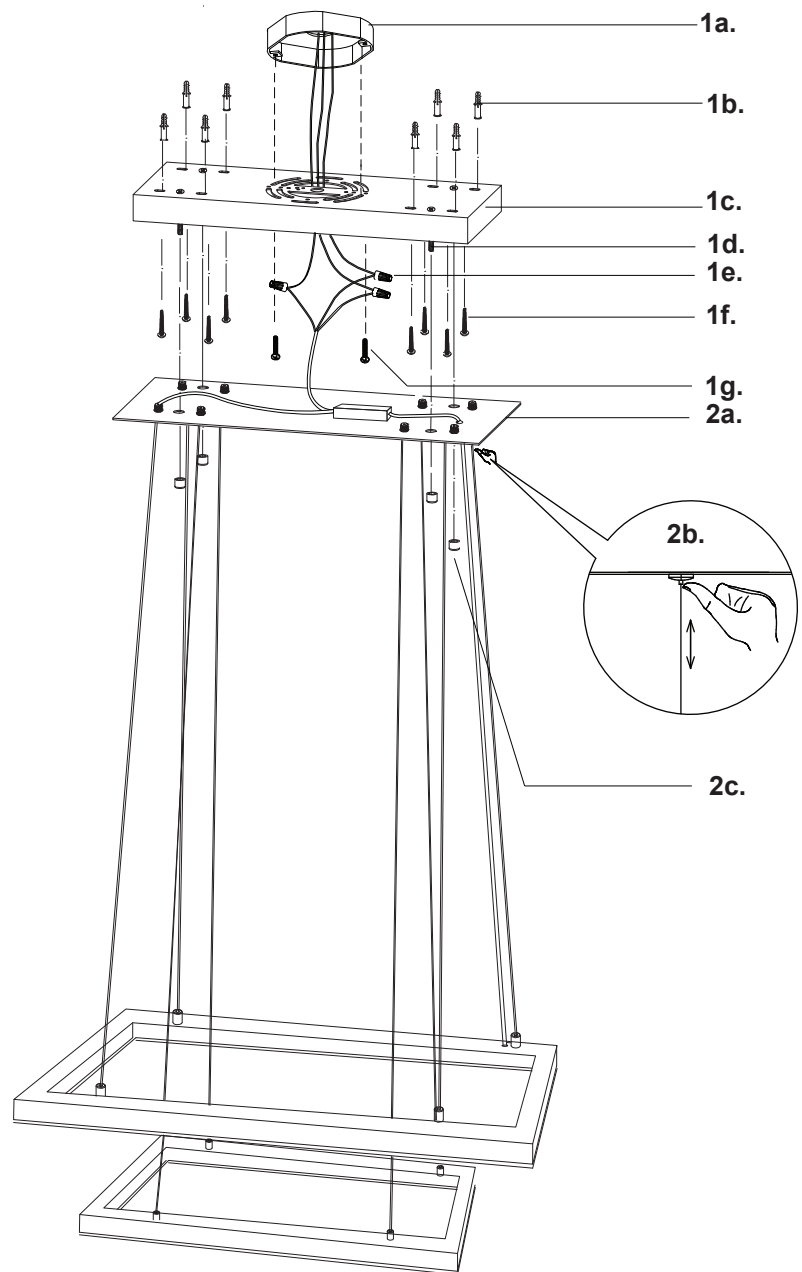

KUZCO
LIGHTING

19054 28th Avenue Surrey, BC Canada V3S 6M3
T: 604 538 7162 TF: 1-855 85 KUZCO F: 604 538 7196
W: kuzcolighting.com
20170504