

# LED Flush Mount

# FM11011-WH

INSTALLATION SHEET

## START FROM HERE

- Make sure power is completely off at the fuse box.
- Have your fixture installed by a qualified licensed electrician
- Prepare everything in a clear area.
- Wear gloves at all times during this installation.
- Read instructions carefully before you start assembly.
- Keep this instruction sheet for future reference.

**Technical Support:** 1-855-855-8926

### Please Note:

- This Kuzco LED fixture comes with pre-wired LED module(s).
- Unless instructed to do so, please do not touch any part of the LED module(s) as any unnecessary contact with the module could cause permanent damage.
- For dimming, an ELV (Electronic Low Voltage) type of dimmer is required.
- 120V input

- 1.** Remove fixture from its original package
- 2.** Separate mounting plate (1c) from fixture backplate (2a) by removing decorative nuts (2c)
- 3.** Align mounting plate screws (1d) to desired orientation, and then attach mounting plate (1c) to electrical junction box (1a) using junction box screws provided (1e) in hardware package
- 4.** Make proper electrical connections (**black to hot "L"**, **white to neutral "N"**, **ground to "GND"**) with wire nuts (1b) provided in hardware package
- 5.** Align and insert mounting plate screws (1d) through holes on fixture backplate (2a), secure with decorative nuts (2c)
- 6.** Secure fixture backplate (2a) to mounting surface with anchors (1f) and screws (1g)
- 7.** Secure glass (3a) to fixture backplate (2a) by tightening screws (2b)

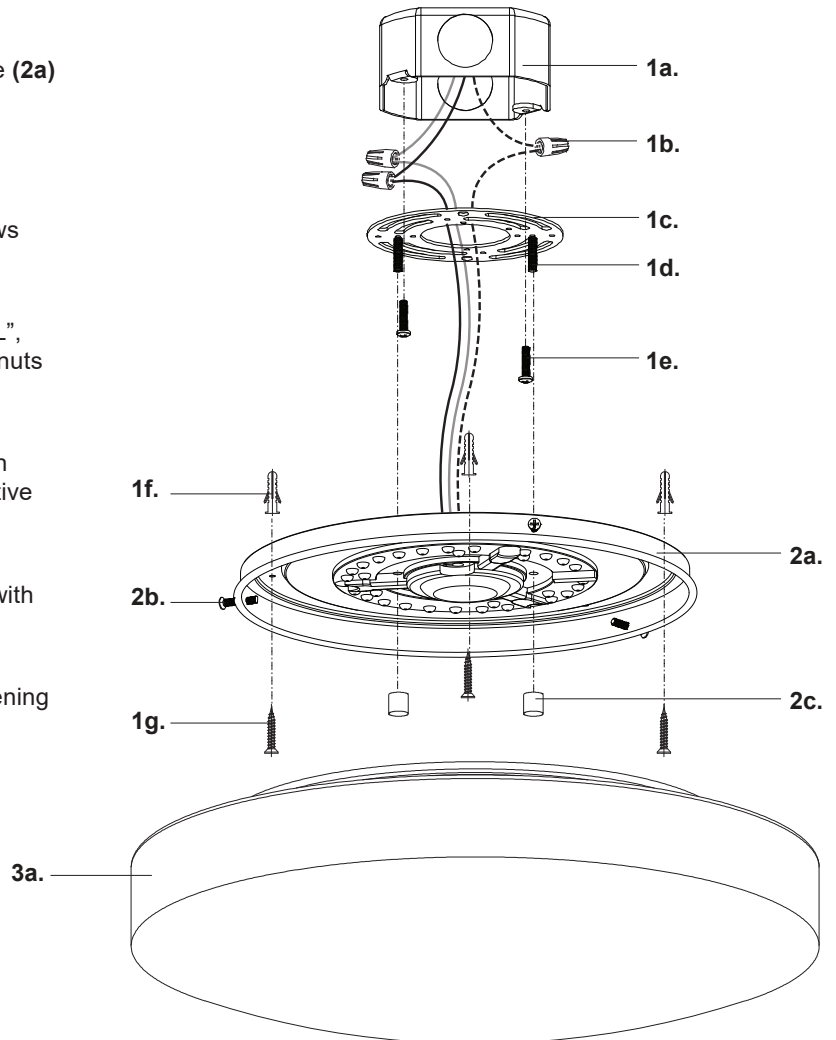

# KUZCO

19054 28th Avenue Surrey, BC Canada V3Z 6M3  
T: 604 538 7162 TF: 1-855 85 KUZCO F: 604 538 7196  
W: kuzcolighting.com  
20220322