

LED Exterior Wall Lamp

EW7516
INSTALLATION SHEET

START FROM HERE

- Make sure **POWER** is **COMPLETELY OFF** at the fuse box
- Have your fixture installed by a qualified licensed electrician
- Prepare everything in a clear area
- Wear gloves at all time during this installation
- Read instructions carefully before you start assembly
- Keep this installation sheet for future reference

Please Note:

- All Kuzco LED fixtures come with pre-wired LED module(s).
- Unless instructed to do so, please do not touch any part of the LED module(s) as any unnecessary contact with the module could cause permanent damage.
- For dimming, an ELV (Electronic Low Voltage) type of dimmer is required.

Technical Support: 1-855-855-8926

- 1.** Remove the fixture from its original packaging. Remove the mounting plate **(1c)** from within the canopy **(1f)** by removing the two nuts **(2a)**. Pull out the mounting plate **(1c)** from within the canopy **(1f)** and attach it to the electrical junction box **(1a)**, using the two screws **(1e)** provided in the hardware package.
- 2.** Attach all wiring with the provided marrets **(1b)** (white to white "N", black to black "L", ground to ground "G"). Align the canopy **(1f)** to the back plate **(1c)** and screw in the two nuts **(2a)** provided to secure the canopy **(1f)** to the back plate **(1c)**.
- 3.** Next, secure the fixture **(2d)** to the canopy **(1f)** using the four set screws **(2c)** using the provided Allen Key.
- 4.** You have now completed the installation of your fixture, do enjoy.

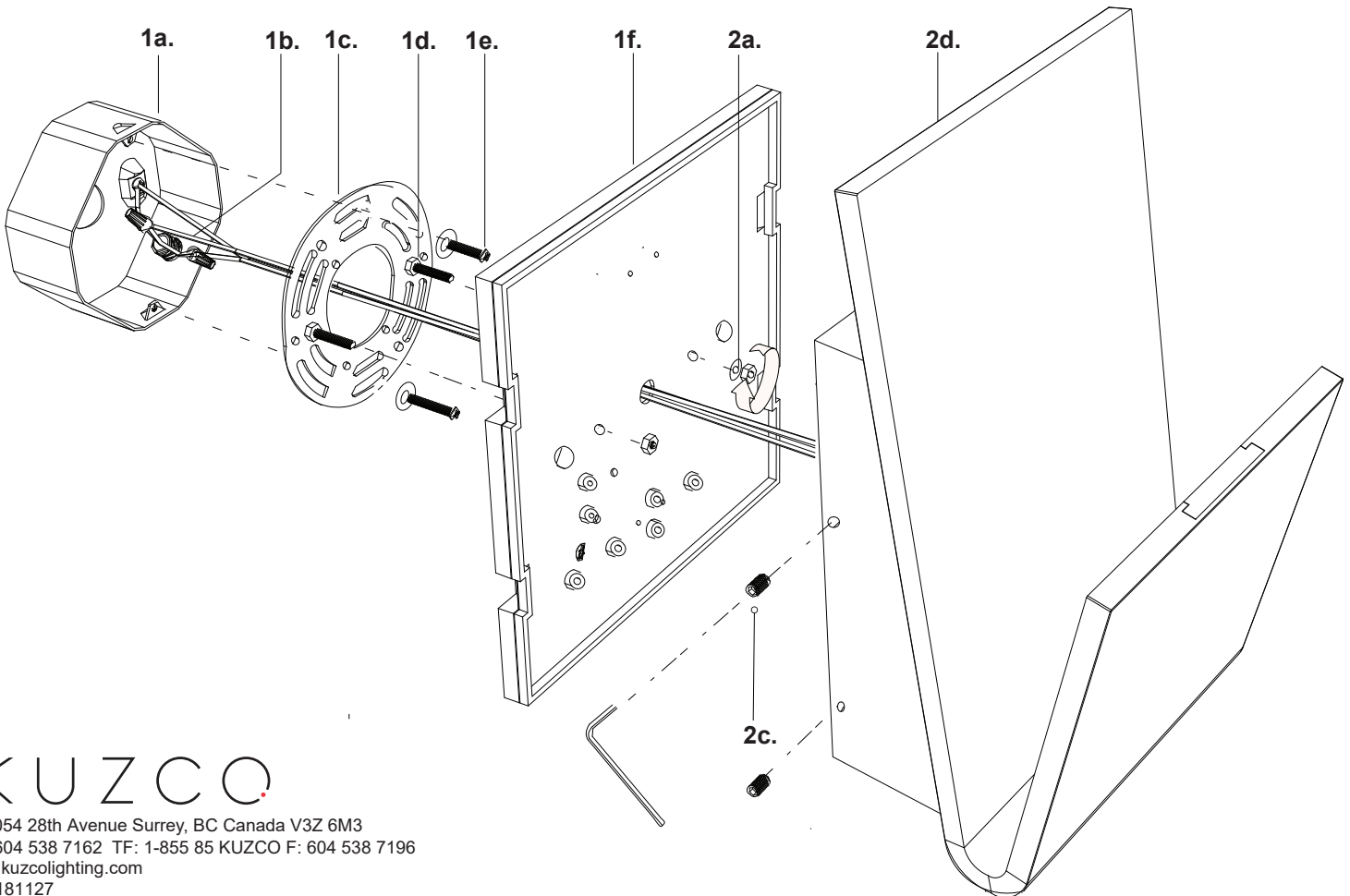

KUZCO

19054 28th Avenue Surrey, BC Canada V3Z 6M3
T: 604 538 7162 TF: 1-855 85 KUZCO F: 604 538 7196
W: kuzcolighting.com
20181127