

Exterior Wall Sconce

EW37201
INSTALLATION SHEET

START FROM HERE

- Make sure power is completely off at the fuse box.
- Have your fixture installed by a qualified licensed electrician
- Prepare everything in a clear area.
- Wear gloves at all times during this installation.
- Read instructions carefully before you start assembly.
- Keep this instruction sheet for future reference.

Technical Support: +1 855 855 8926

Please Note:

- All Kuzco LED fixtures come with pre-wired LED module(s).
- Unless instructed to do so, please do not touch any part of the LED module(s) as any unnecessary contact with the module could cause permanent damage.
- For dimming, an ELV (Electronic Low Voltage) type of dimmer is required.

- 1.** Remove the fixture from its original packaging. Remove the mounting plate **(1c)** from within the fixture **(2b)** by loosening the screws **(2a)**. Secure the mounting plate **(1c)** to the junction box **(1a)** with screws **(1d)** provided in the hardware package.
- 2.** Attach the fixture **(2b)** to the mounting plate **(1c)**, which is attached to the electrical junction box **(1a)** on the wall. First attach all wiring with the provided marrettes **(1b)** (white to white "N", black to black "L", ground to ground "G"). Now attach the fixture **(2b)** onto the mounting plate **(1c)** with the two screws **(2a)**.
- 3.** You have now completed the installation of tyour fixture, enjoy.

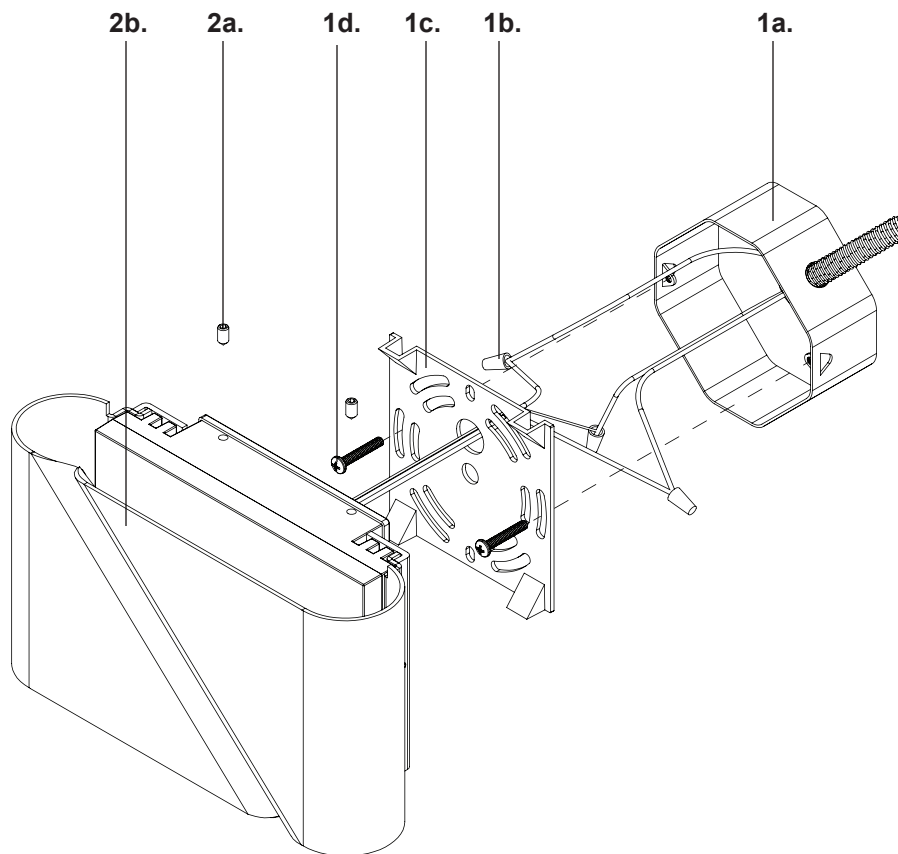

KUZCO

19054 28th Avenue Surrey, BC Canada V3Z 6M3
T: 604 538 7162 TF: 1-855 85 KUZCO F: 604 538 7196
W: kuzcolighting.com
20190603