

Exterior LED Lamp Wall Sconce

EW1508
INSTALLATION SHEET

START FROM HERE

- Make sure power is completely off at the fuse box.
- Have your fixture installed by a qualified licensed electrician
- Prepare everything in a clear area.
- Wear gloves at all times during this installation.
- Read instructions carefully before you start assembly.
- Keep this instruction sheet for future reference.

Technical Support: 1-877-452-6858

Please Note:

- All Kuzco LED fixtures come with pre-wired LED module(s).
- Unless instructed to do so, please do not touch any part of the LED module(s) as any unnecessary contact with the module could cause permanent damage.
- For dimming, an ELV (Electronic Low Voltage) type of dimmer is required.

- 1.** Remove the fixture from its original packaging. Remove the mounting plate (1d) from within the canopy (2b) and attach it to the electrical junction box (1a), using the two screws (2a) provided in the hardware package.
- 2.** Attach the canopy backplate (2b) to the mounting plate (1d), which is attached to the electrical junction box (1a) on the wall. First attach all wiring (1b) with the provided marrets (white to white "N", black to black "L", ground to ground "G"). Now push the canopy backplate (2b) onto the mounting plate (1d) allow the screws (1c) to pass through the backplate holes (2c). Next, thread the nuts and washers (2d) onto the screws (1c) this will secure the fixture to the wall.
- 3.** Next place the gasket (3a) onto the canopy backplate (2b), second the diffuser (3b), followed by the casing (3c) and secure with the four screws (3d).
- 4.** To prevent moisture from entering the outlet box and causing a short, seal around the top and side perimeter between the fixture and the wall surface with weather resistant caulking (see illustration 3). The space at bottom should be left un-caulked to prevent moisture build-up. Apply a small amount of weather resistant caulking around the side perimeter between the cap nut and mounting plate.
- 4.** You have now completed the installation of your fixture, enjoy.

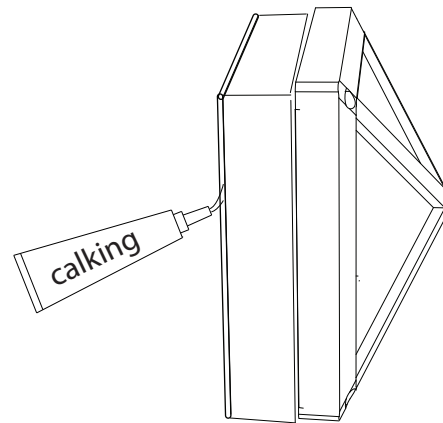
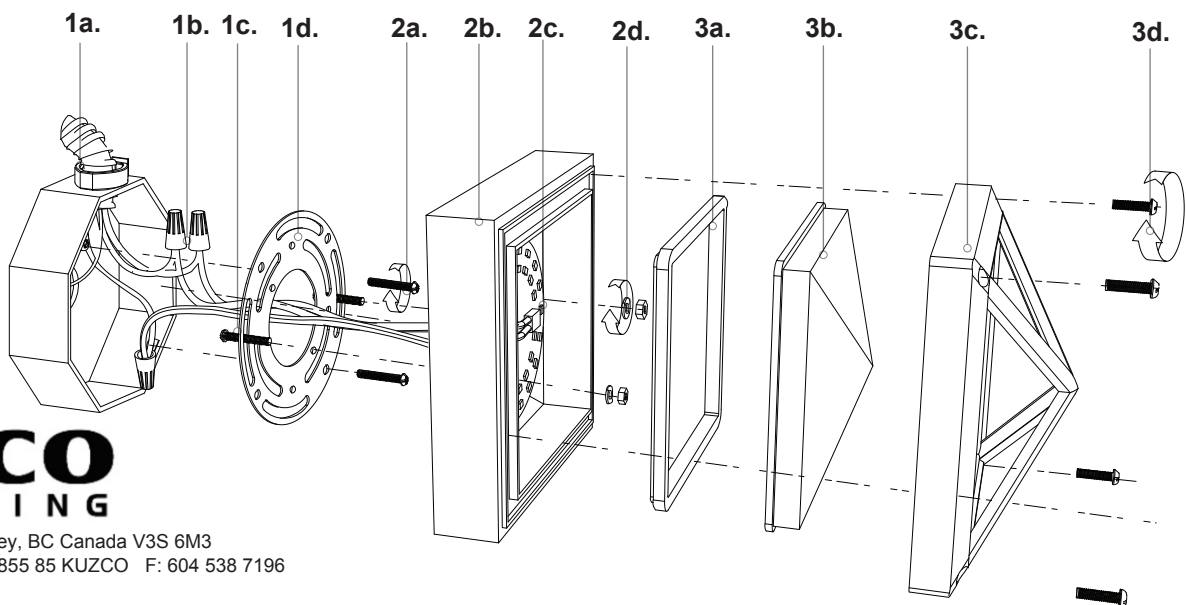

illustration 3



KUZCO
LIGHTING

19054 28th Avenue Surrey, BC Canada V3S 6M3
T: 604 538 7162 TF: 1-855 85 KUZCO F: 604 538 7196
W: kuzcolighting.com
20160726