

LED Chandelier

CH19732
INSTALLATION SHEET

START FROM HERE

- Make sure power is completely off at the fuse box.
- Have your fixture installed by a qualified licensed electrician
- Prepare everything in a clear area.
- Wear gloves at all times during this installation.
- Read instructions carefully before you start assembly.
- Keep this instruction sheet for future reference.

Technical Support: 1-855-855-8926

Please Note:

- For dimming, a TRIAC or an ELV type of dimmer is required.

- 1.** Remove the fixture from its original packaging. Next, remove the mounting plate (1c) from the canopy (2a) by removing the screws (2b). Install the mounting plate (1c) to the junction box (1a) with screws (1d). For additional support, add wood screws (1e) to plastic anchors (1f) in the ceiling.
- 2.** Next, attach all the diffusers (3b) to the fixture arms (3a). Before you mount the canopy to the mounting plate, select the desired length of the fixture to hang. First screw on the connector (2c) to the canopy. Add extension rods (2d) by threading clockwise. Next pull the wire (2e) through the extension rods into the canopy.
- 3.** You are now ready to mount the canopy to the mounting plate. First connect all wires correctly G ground to ground, N neutral wire (white to white), L live wire (black to black) with provided marrettes (1b) from the hardware package. Push the canopy (2a) up towards the ceiling and screw on the screws (2b), this will secure the canopy (2a) to the mounting plate (1c).
- 4.** You have now completed the installation of your fixture, enjoy.

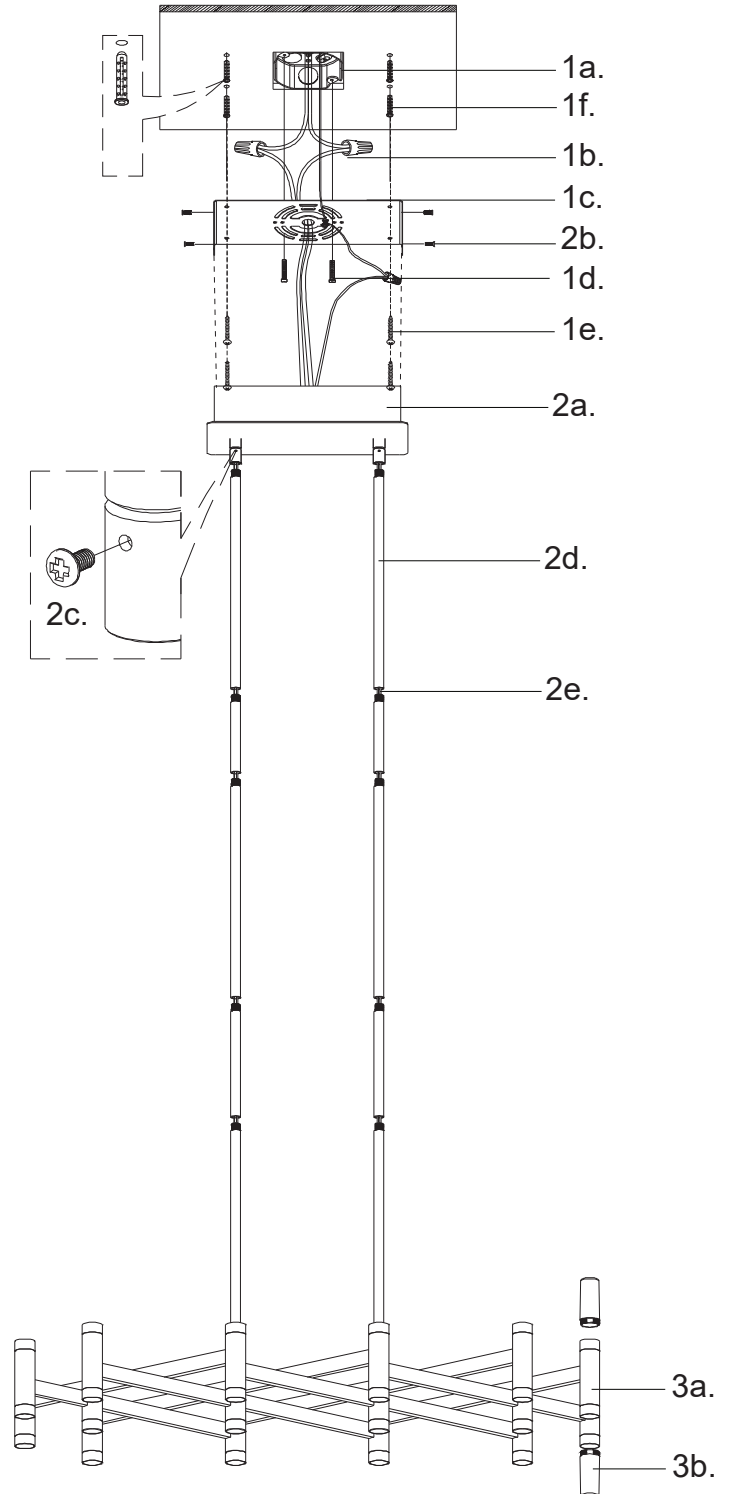

KUZCO

19054 28th Avenue Surrey, BC Canada V3Z 6M3
T: 604 538 7162 TF: 1-855 85 KUZCO F: 604 538 7196
W: kuzcolighting.com
20190108