

LED Vanity Lamp

VL56221
INSTALLATION SHEET

START FROM HERE

- Make sure power is completely off at the fuse box.
- Have your fixture installed by a qualified licensed electrician
- Prepare everything in a clear area.
- Wear gloves at all times during this installation.
- Read instructions carefully before you start assembly.
- Keep this instruction sheet for future reference.

Technical Support: 1-877-452-6858

Please Note:

- All Kuzco LED fixtures come with pre-wired LED module(s).
- Unless instructed to do so, please do not touch any part of the LED module(s) as any unnecessary contact with the module could cause permanent damage.
- For dimming, an ELV (Electronic Low Voltage) type of dimmer is required.

- 1.** Remove the fixture from its original packaging. Remove the two screws **(2c)** and pull the mounting plate **(2a)** out from within the canopy **(2d)**. Attach the mounting plate **(2a)** to the electrical junction box **(1a)**, using the two screws **(2b)** provided in the hardware package.
- 2.** You are now ready to mount the canopy **(2d)** to the mounting plate **(2a)**. Attach all wiring **(1b)** with the provided marrets (white to white "N", black to black "L", ground to ground "G"). To mount the backplate to the canopy tilt bottom inward followed by rotating the top (illustration_01). Align the holes on the top and bottom of the canopy to the holes on the canopy back plate. Once aligned, screw in, top and bottom the two screws **(2c)** provided, this will secure the canopy **(2c)** to the back plate **(2a)**.

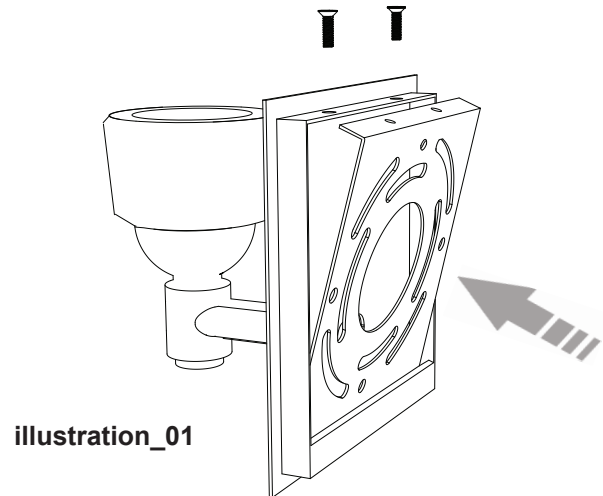

- 3.** LED Engines are built in. Place the glasses **(3a)** down to the LED engines **(3b)** and thread turning clockwise.
- 4.** You have now completed the installation of your fixture, enjoy.

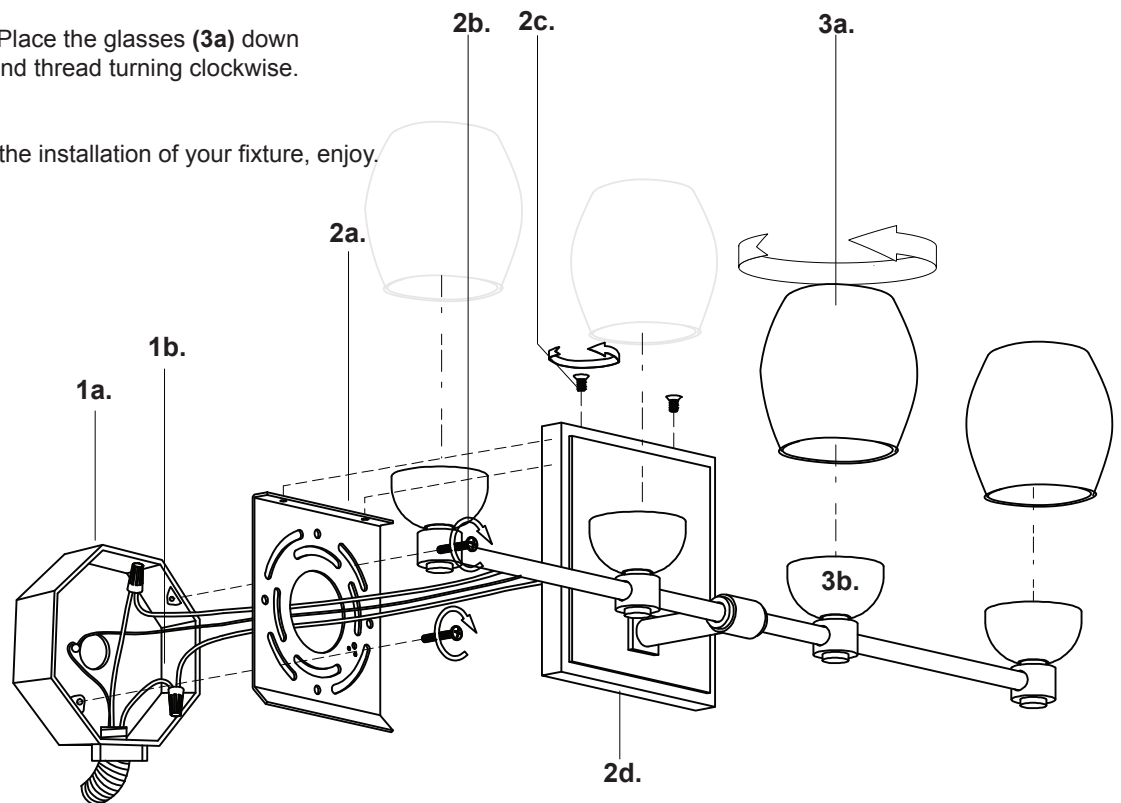

KUZCO
LIGHTING

19054 28th Avenue Surrey, BC Canada V3S 6M3
T: 604 538 7162 TF: 1-855 85 KUZCO F: 604 538 7196
W: kuzcolighting.com
20160630